

REVISIONS		
ISS	ZONE	DESCRIPTION\PER REQUEST\DATE
a		First issue - obsolete -replaced by issb
B		Modified p/n and spec, release by livia

3rd ANGLE PROJECTION  THIS DOCUMENT AND THE DESIGN SHOWN THEREON IS THE PROPERTY OF ROJONE PTY LTD AND MUST NOT BE SOLD, LENT, GIVEN AWAY, COPIED, REPRODUCED OR OTHERWISE DIVULGED TO ANY THIRD PARTY OR USED FOR MANUFACTURE, OR ANY OTHER PURPOSE WITHOUT DIRECT WRITTEN PERMISSION OF ROJONE PTY LTD. DO NOT SCALE

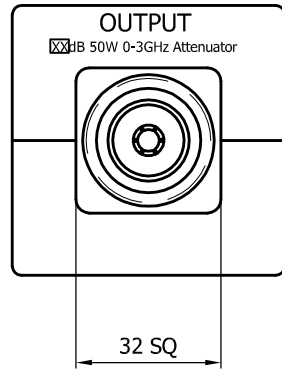
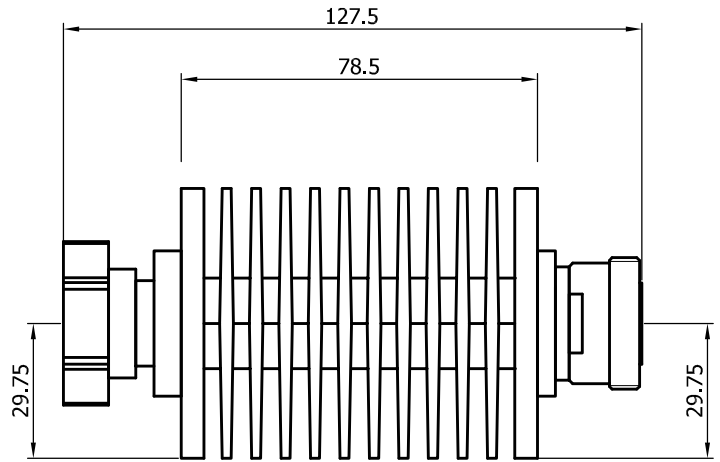
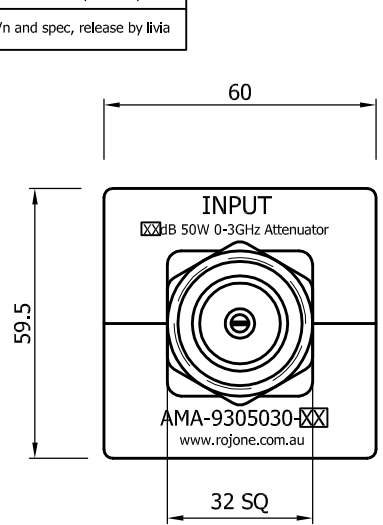

REVISION	DATE	CHECKED
A	20130625	H. JIA
B	2014-03-14	L. B.

Rojone P/N Ordering Detail

AMA-9 3 050 30-XX

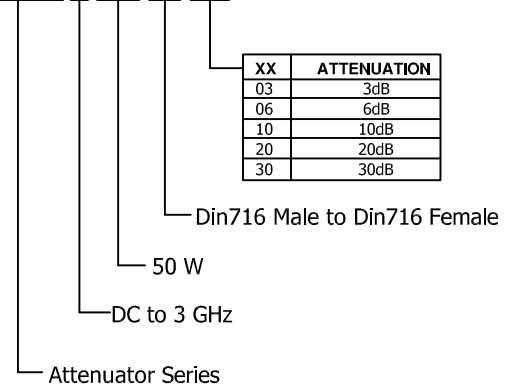

XX	ATTENUATION
03	3dB
06	6dB
10	10dB
20	20dB
30	30dB

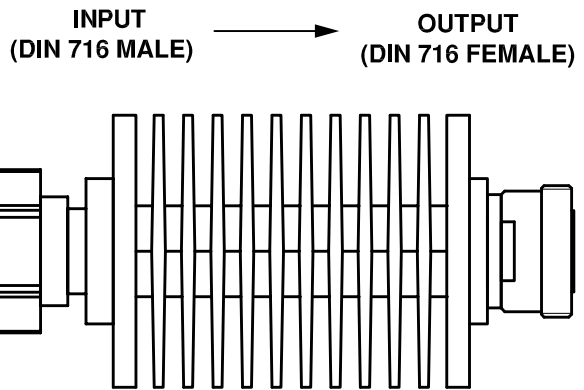

**SPECIFICATIONS
AMA-9305030-XX**

- FREQ: DC TO 3GHz
- VSWR: < 1.15 (DC TO 1.0 GHz)
< 1.35 (1.0 TO 3.0 GHz)
- ATTENUATION: 3,6,10,20,30 dB (See Rojone P/N)
- ATTEN ACCUR: ±0.3dB OR 3%W.I.G. Typ
- RF INPUT POWER: 50 W CW @ 20 °C
- PEAK PWR: 10 KW MAX (10 us)
- OP TEMP: -20 to +50 °C
- WEIGHT: 540 g
- CONN: DIN 716 MALE for INPUT
DIN 716 FEMALE for OUTPUT

UNLESS OTHERWISE STATED ALL DIMENSIONS ARE IN MILLIMETRES (mm) TOLERANCE: LINEAR +0.1 ANGULAR +1° REMOVE ALL BURRS AND SHARP EDGES

 ROJONE PTY LTD ACN 002691241 44 AERO RD INGLEBURN 2565 SYDNEY, AUSTRALIA Ph: (612) 9829 1555 Fax: (612) 9605 8812 Web: www.rojone.com.au E-mail: sales@rojone.com.au	TITLE INTERFACE FOR AMA-9305030-XX XXdB 50W 0-3GHz DIN ATTENUATOR		
	DRWG No: 003001001204		
MATERIAL	DRAWN Y. GU	SCALE NTS	SHEET 1 OF 1
FINISH	CHECKED H. JIA	APPROVED L. B.	FILENAME 003001001204ISSB.DWG

A4