

2 W COAXIAL TERMINATIONS

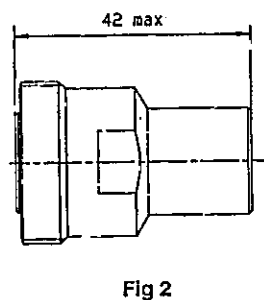

part number	frequency range (GHz)	fig.	V.S.W.R.			power (W)		weight (g)
			DC - 2	2 - 4		Avg.	peak	
R404 170 111	DC - 4 GHz	1	< 1.10	< 1.30	2	500	120	
R404 175 111		2					115	

12 and 25 W COAXIAL TERMINATIONS

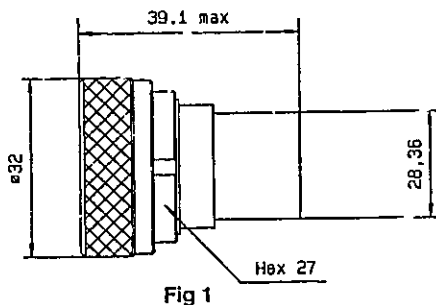
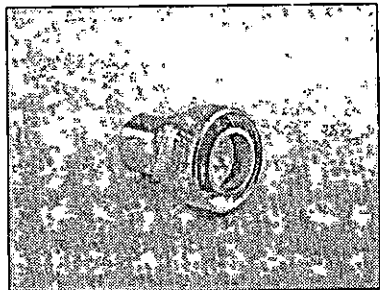
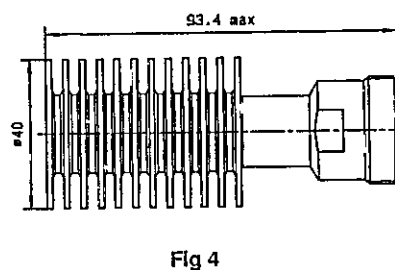
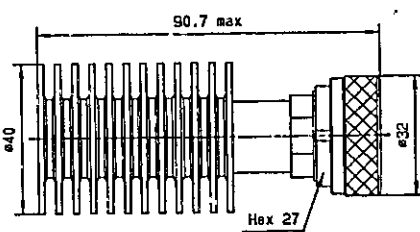
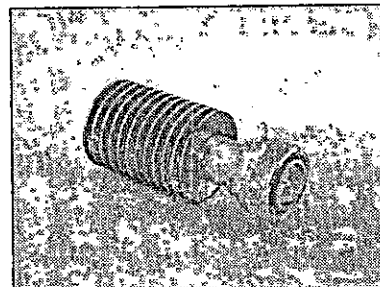
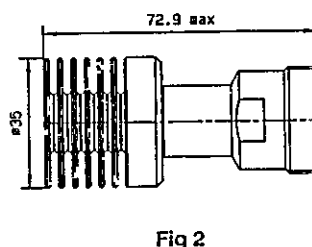
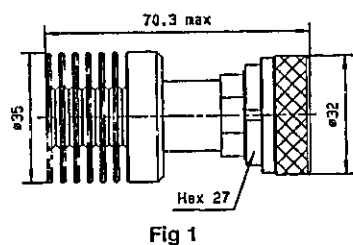
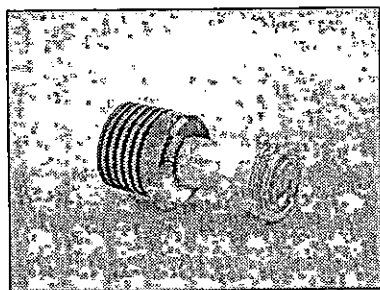

part number	frequency range (GHz)	fig.	V.S.W.R.			power (W)		weight (g)
			DC - 1	1 - 2	2 - 4	Avg.	peak	
R404 564 000	DC - 4 GHz	1	< 1.10	< 1.10	< 1.20	12	4000	170
R404 564 500		2						165
R404 836 118	DC - 2 GHz	3	< 1.10	< 1.20		25	5000	210
R404 837 118		4						205